

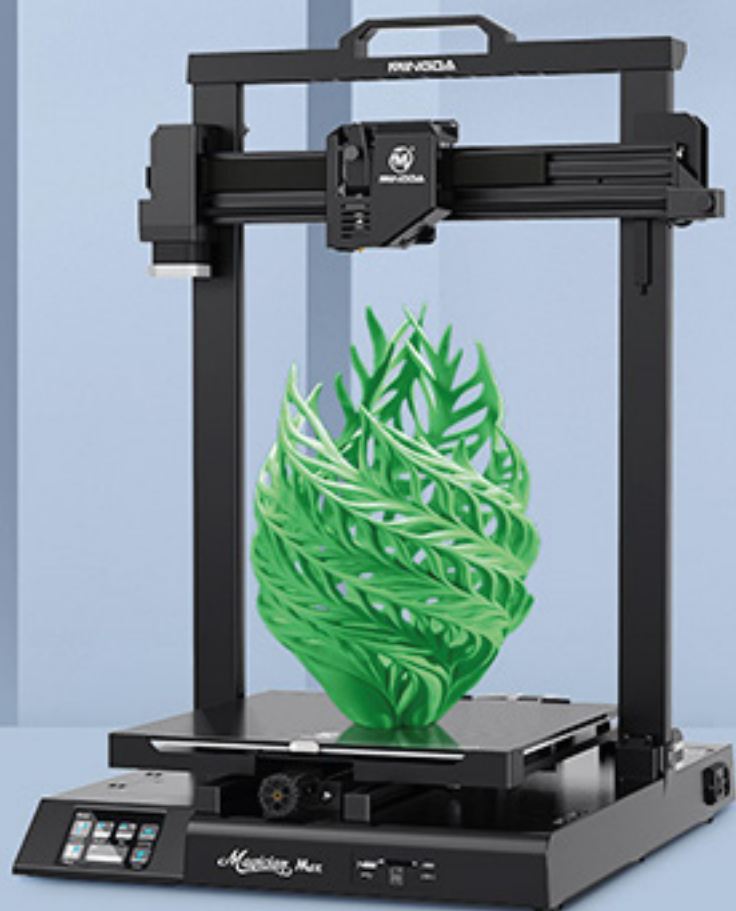

MINGDA

**Marvelous, Amazing,
Auto Leveling
eXtreme For Your Printing**

320*320*400mm



Innovator of Auto-Leveling

Say goodbye to manual leveling, the intelligent leveling system can automatically adjust the uneven hotbed. High-sensitivity sensor, one-touch leveling and 16-point precise leveling.

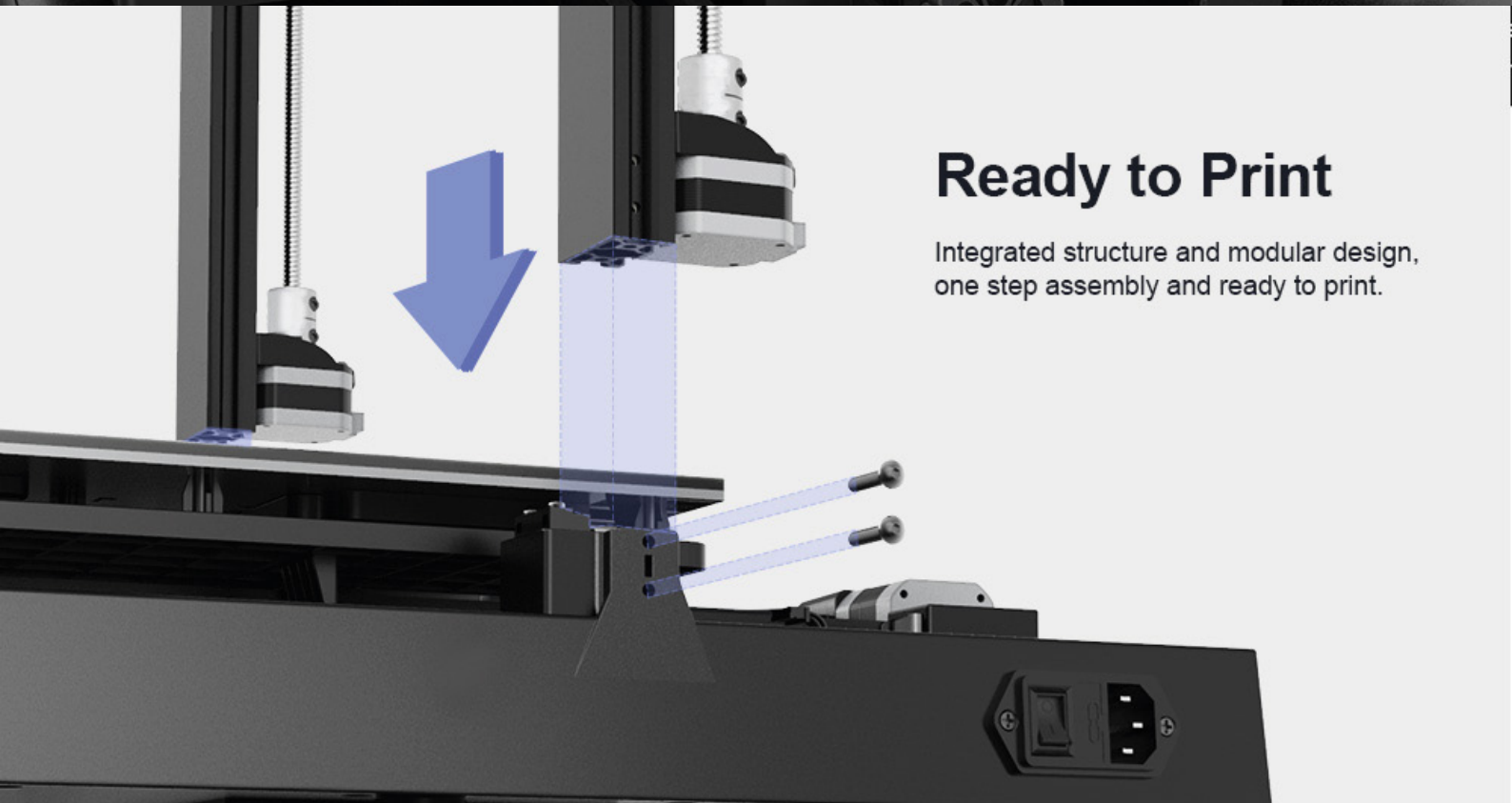
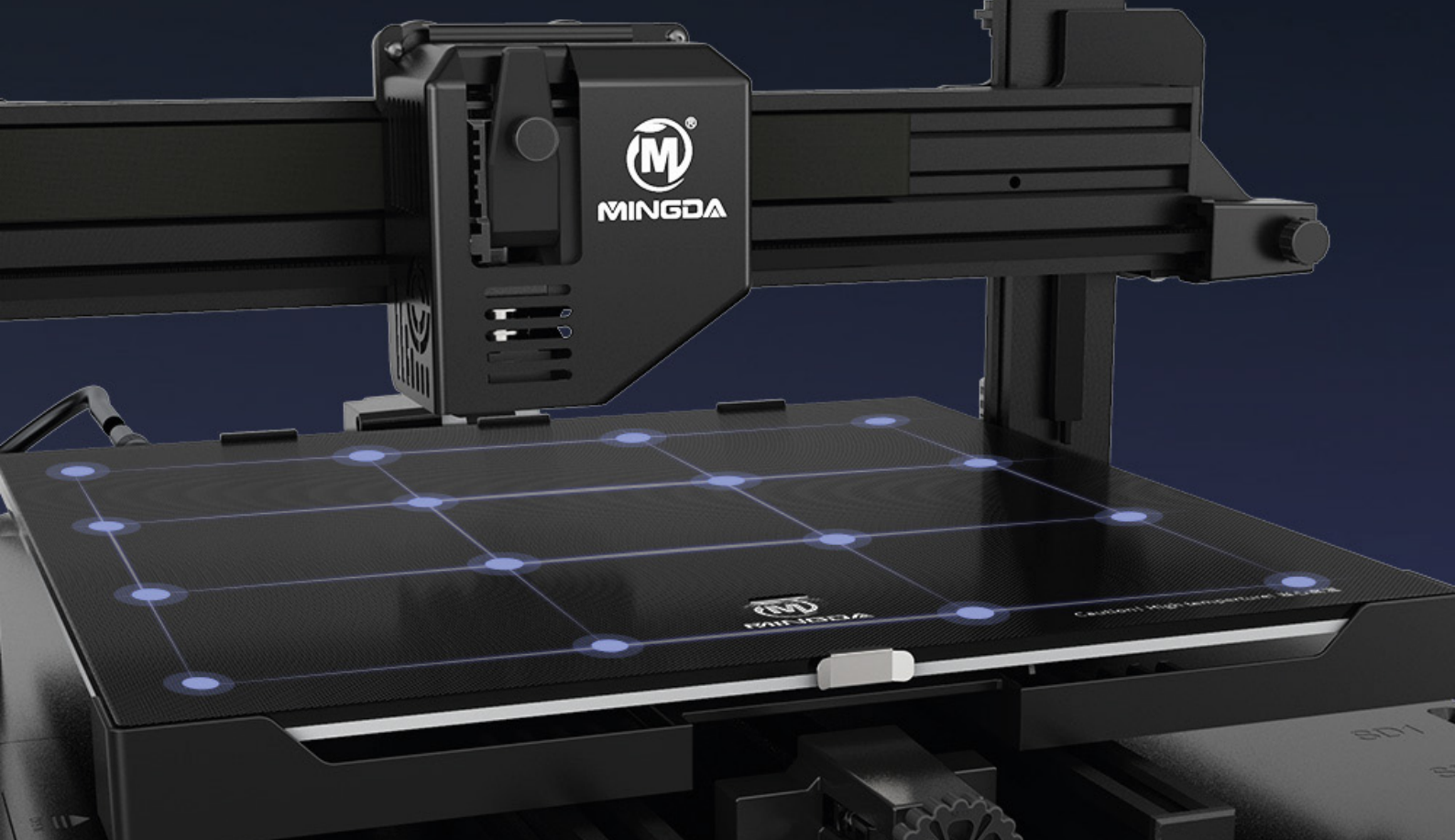

Ready to Print

Integrated structure and modular design, one step assembly and ready to print.

Ultra-Silent Printing

Ultra-quiet mechanical structure & Self-developed Mother Board with TMC, you will not be hearing any noise while printing, enjoy a happy printing time

After noise reduction

40~50 dB

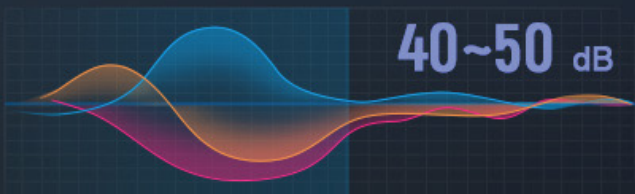

TMC Chips Silent Drivers



Ultra-Silent

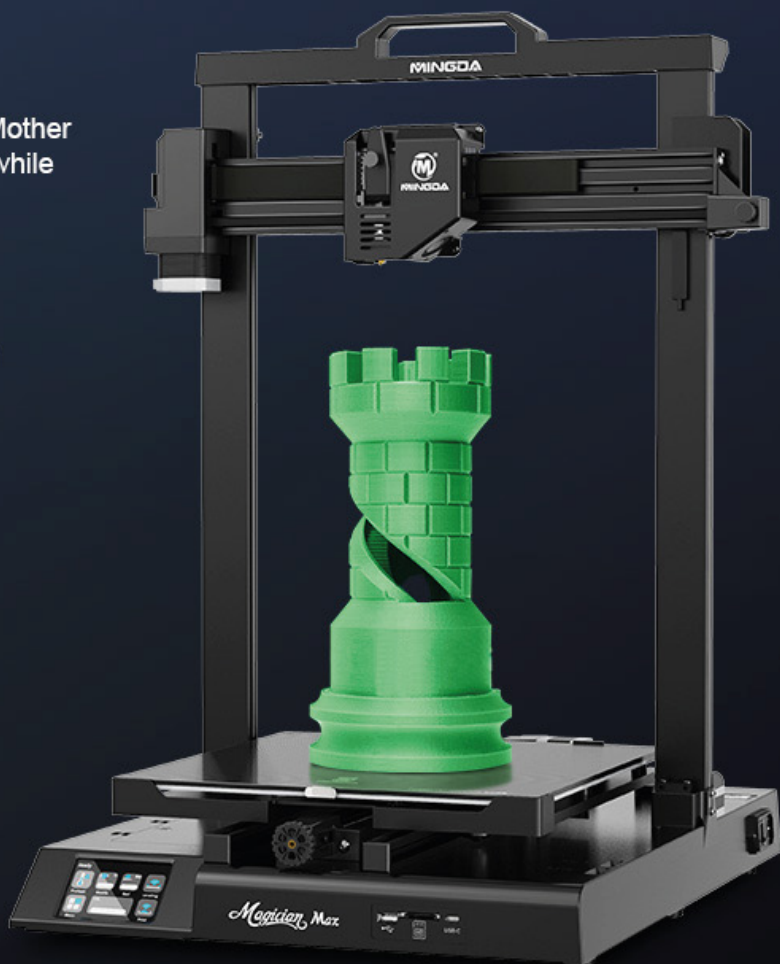

Dual Cooling Fans

The printing head adopts a double fan two-way heat dissipation system, cools down models rapidly. The printing speed is faster which can reach 100mm/s.

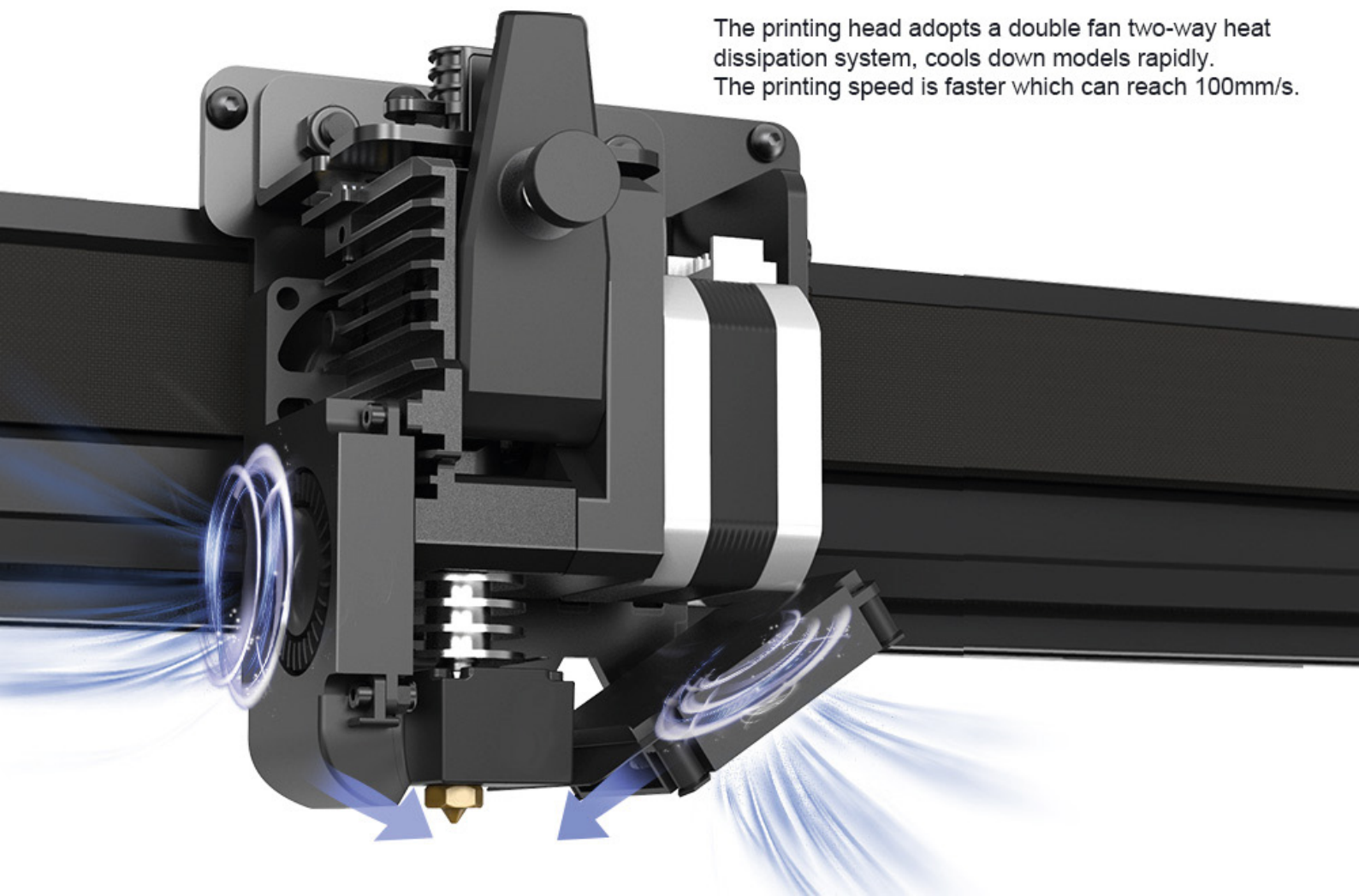

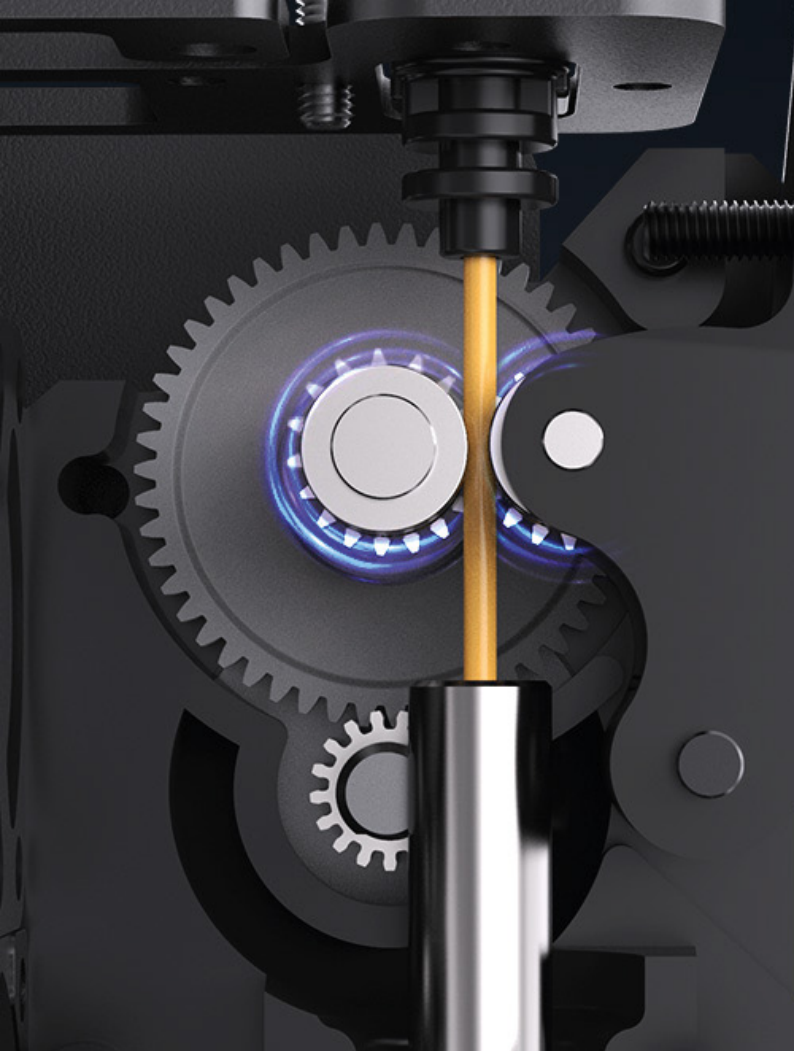

Double Gears Direct Extrusion

Conveying material uniformity without winding

Glass Heat Bed

4th gen glass heat bed with cold glue installation,
easy to carry and is scratch proof.



Patented Dual Z-Axis with Synchronous Belt

Ensure the accuracy of the print head in the X-axis direction.



Large Printing Size

320(L)*320(W)*400(H)mm

The printer can meet your endless creative needs.

Built-in Filament Detector and Resume Printing



Automatic
Filament Detection



Resume
Printing Function

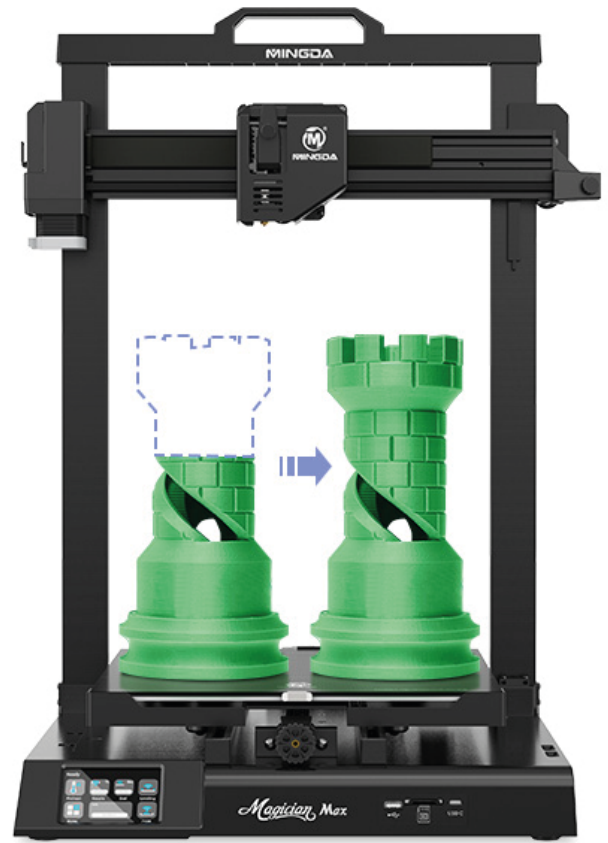

Multi Connection

Support SD card, USB and USB-C,
supports online printing.



U Disk



SD Card



USB-C

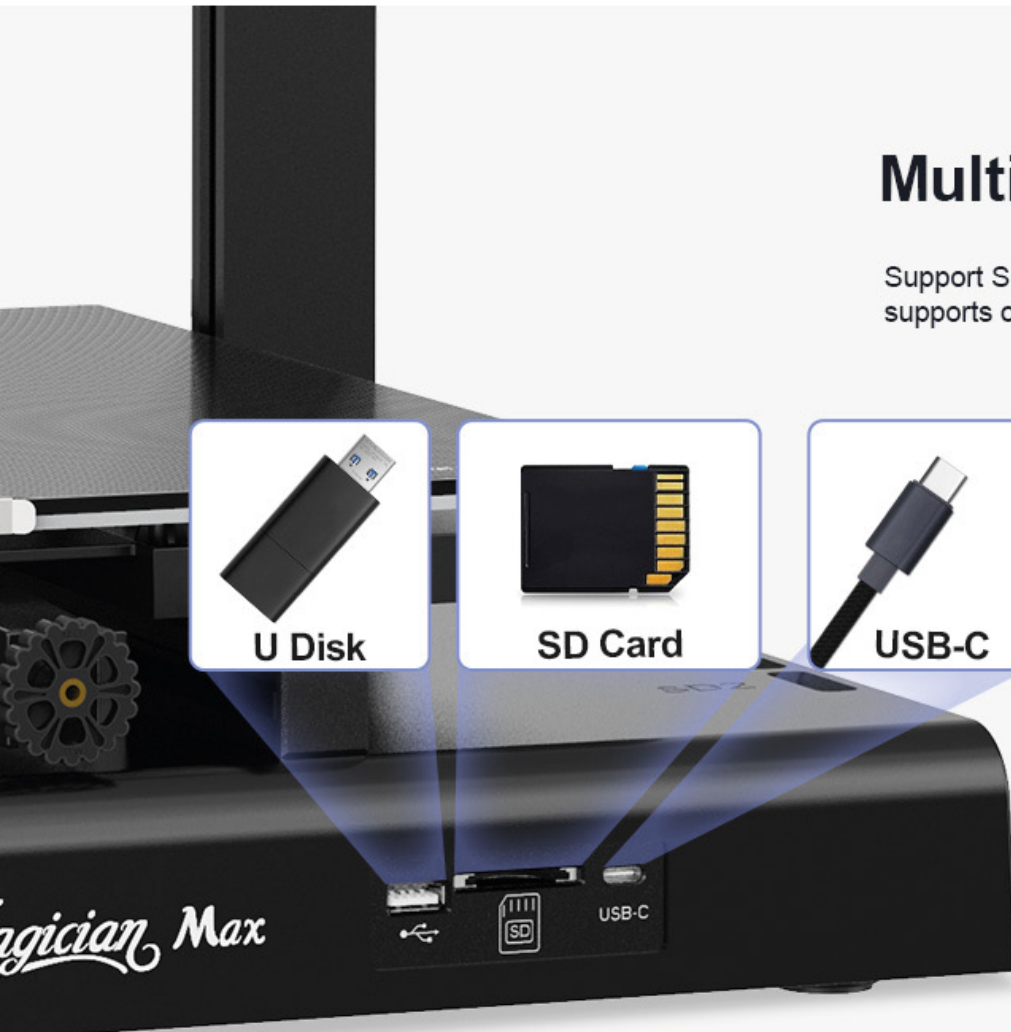

Powerful Chip with High Performance and Efficiency

High-speed computing; high-performance, 32-bit frequency: 168M; Cortex-M4 CPU with FPU and DSP instruction, memory protection unit.

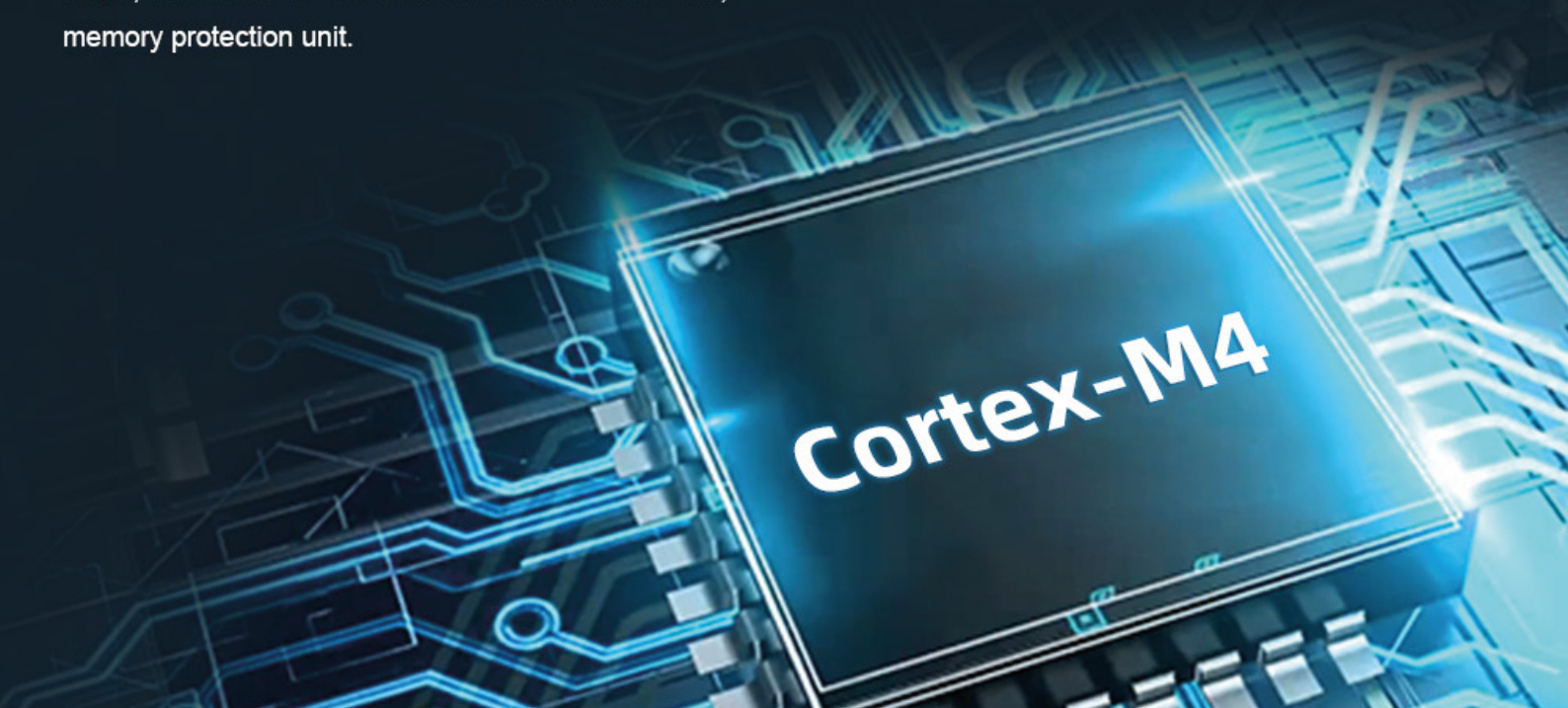

3.5" Large Touch Screen

The screen adopts a new UI interface, manipulate photos, and switch in multiple languages. New interface; large screen; simple operation.





Belt Tensioner on X/Y Axis

Adjust the belt tightness to avoid long-term use of the printer, the belt is loose.



Technical Specification

Print size	32×32×40cm
Calibration	Self-developed Automatic Leveling
Filament diameter	1.75 mm
Printing material	PLA / ABS / PETG & TPU
Nozzle size	0.4mm default, wide range of other nozzles supported
Extuder	Direct Drive,Double Gears
Filament run-out detection	Support
Resume Printing	Support
Tool Box	Yes
Max nozzle temperature	260 °C
Max heatbed temperature	110 °C
Average speed	6-8 cm/s,
Control panel	3.5 inch colorful LCD touch screen
Print interface	SD Card,U Disk,USB-C
Z-axis	Double threaded rod with synchronous belt
Machine Weight	10kg
Machine Dimension	5.5 x 43 x 66cm(X*Y*Z)

Tutti i marchi riportati appartengono ai legittimi proprietari; marchi di terzi, nomi di prodotti, nomi commerciali e immagini di prodotti sono di proprietà dei rispettivi titolari.
Sono utilizzati a puro scopo divulgativo e informativo, senza alcun fine di violazione dei diritti vigenti.

> visita il nostro sito machpower.it

Le caratteristiche potrebbero variare senza preavviso.

REV01-020524